

- Installation Relays
- Stair case lighting time

CR 8 01



Kühn Controls AG
 Vertriebsbüro Deutschland
 Gräfenhäuser Str. 14
 D-75305 Neuenbürg
 Tel.: +49- (0)7082-940000
 Fax: +49- (0)7082-940001
 eMail: sales@kuehn-controls.de
 www.multicomat.net

Power Relays Step-on Step-off Relays

Staircase Lighting Timers

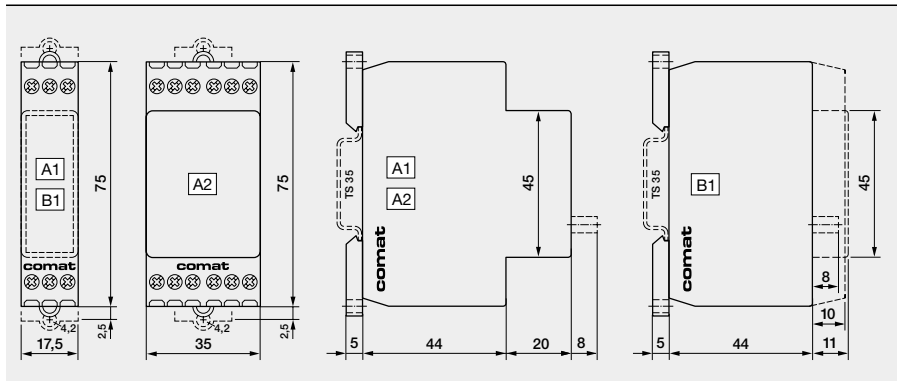

if This series has been awarded the if mark for outstanding industrial design.

As a particular and common characteristic the comat light control devices/staircase lighting timers of the series AL2, AL3, AL4 and AL5 have a twin-contact output with one side of the early make contact made of tungsten. A tungsten contact with its extremely high melting point can conduct exceptionally high currents, i.e. up to 600A until, in the case of short-circuit the fuse connected in series triggers. Or up to 120A for 20ms, as can appear when switching compensated fluorescent lamps or other gas discharge lamps. With this characteristic a welding of contacts can be reliably prevented.

The devices in the AL4 and AL5 series are made for central control of switching functions and can also be used for the operation with extra-low voltages: The professional solution for installations in schools, homes, authorities, industrial environments connected to a control central or to various illuminated push buttons (LED or glow lamps) up to 40 mA.

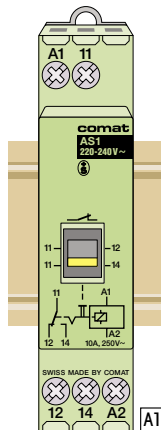

AS1 Step-on Step-off Relays

- Power change-over contacts 10A, 250V~
- Remanence relay, manual operation
- Mechanical output status

AC ~	UC ≈
50/60 Hz	~/~/~
220-240V	48-60V
110-127V	24-36V
	12-15V
-15/+10%, 0,25-0,5W nom	

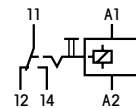

1) | 10A, 250V~

μ AgCdO
2200VA, ≤ 150W (DC)

2x10⁷ mechanical life

1) Values for resistive loads

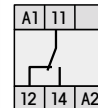

Ex. of order: 1 Step-on Step-off Relay AS1/AC220-240V

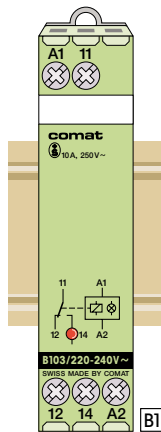

B103 Power Relays

- Power change-over contacts 10A, 250V~
- Freewheel diode and DC reverse-polarity protection
- LED output status

AC ~	UC ≈
50/60 Hz	~/~/~
220-240V	24, 48V
110-127V	8-12V
-15/+10%, 0,8-1,25W nom	

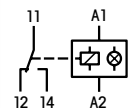

1) | 10A, 250V~

μ AgCdO
2200VA, ≤ 200W (DC)

2x10⁷ mechanical life

1) Values for resistive loads



Ex. of order: 1 Power Relay B103/AC220-240V

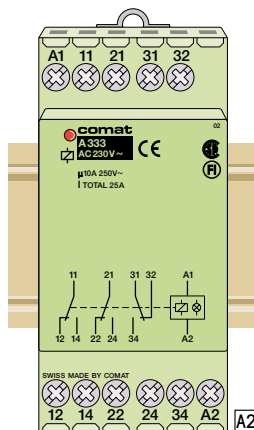

A333 Power Relays

- Power change-over contacts 10A, 250V~
- Freewheel diode and DC reverse-polarity protection
- LED output status

AC ~	DC ≈
50/60 Hz	~/~/~
230, 110V	24, 48V
24, 48V	12V
-15/+10%, 2,2VA/1,2W nom	

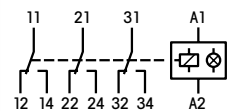

1) | 10A, 250V~

μ AgCdO
1500VA, ≤ 200W (DC)

2x10⁷ mechanical life

1) Values for resistive loads



Ex. of order: 1 Power Relay A333/AC220V

AL1 Staircase Lighting Timers

- For small to medium-sized installations
- Single contact 10A, 250V~
- 30s-10min running time, infinitely adjustable
- subsequent time operation from zero, manual ON

t AL1
30s - 10min
AC ~ 50/60 Hz
220-240, 110-127V
-15/+10%, 1 W nom
1) 10A, 250V~
μl AgCdO
2200VA, ≤ 200W (DC)
2x10 ⁷ mechanical life
1) Values for resistive loads

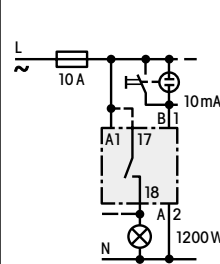

Ex. of order: 1 Staircase Lighting Timer AL1/AC220-240V

AL2 Staircase Lighting Timers (120A)

- With special contact for high lamp loads
- 120A special early make contact
- 30s-10min running time, infinitely adjustable
- subsequent time operation from zero, manual ON

t AL2
30s - 10min
AC ~ 50/60 Hz
220-240, 110-127V
-15/+10%, 1 W nom
1) 10A, 250V~
μl Tungsten/AgCdO
2200VA, ≤ 200W (DC)
3x10 ⁷ mechanical life
1) Values for resistive loads

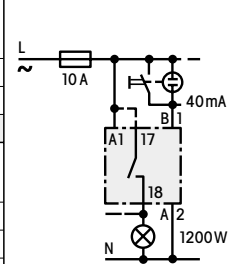

1 Staircase Lighting Timer AL2/AC220-240V

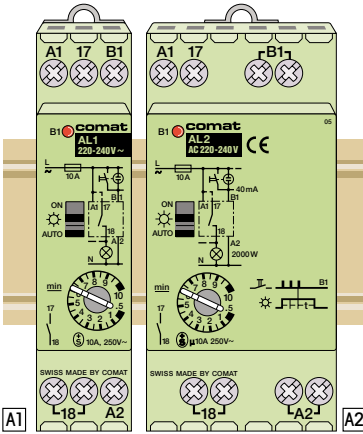

AL3 Universal Staircase Lighting Timers 10(120)A

- With stepping switch functions LS and S
- 120A special early make contact
- 30s-1h running time, infinitely adjustable
- subsequent time operation from zero, manual ON

AC ~ 50/60 Hz	UC ~ 24V	t AL3
220-240V	24V	0,5 - 60min
110-127V		0,5-6 min 5-60 min
48-60V		Y4 Y5 Y4 Y5
-15/+10%, 1 W nom		
1) 10A, 250V~		1) Values for resistive loads
μl Tungsten/AgCdO		
2200VA, ≤ 200W (DC)		
3x10 ⁷ mechanical life		

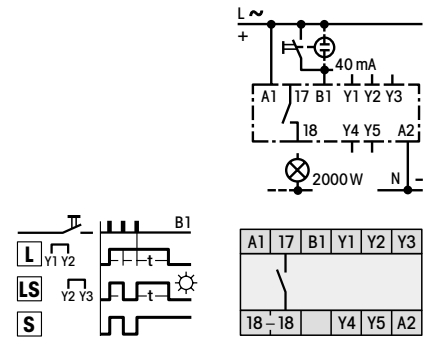

Example of order: 1 Staircase Lighting Timer AL3/AC220-240V

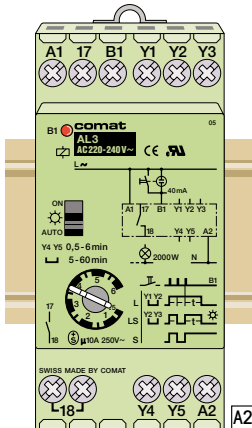

AL4 (C) Staircase Lighting Timers for central control 10(120)A

- Two-way lighting control on-off, stepping switch
- 120A special early make contact
- 30s-1h running time, infinitely adjustable
- subsequent time operation from zero, manual ON

AC ~ 50/60 Hz	UC ~ 24V*	t AL4, AL4C
220-240V	24V*	0,5 - 60min
110-127V	* only AL4 not AL4C	0,5-6 min 5-60 min
48-60V*		
-15/+10%, 1,2 W nom		
1) 10A, 250V~		1) Values for resistive loads
μl Tungsten/AgCdO		
2200VA, ≤ 200W (DC)		
3x10 ⁷ mechanical life		

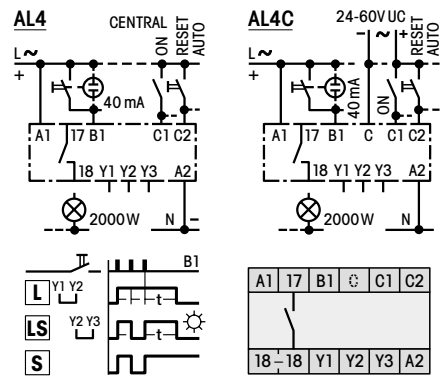

Example of order: 1 Staircase Lighting Timer AL4/AC220-240V

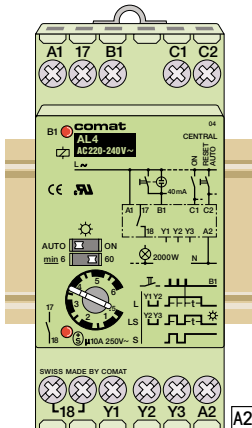

AL5 Power step-on step-off relay for central control 10(120)A

- Stepping switch funct. S
- Central ON-OFF
- 120A special early make contact
- Output status
- Neon lamps by AC control

AC ~ 50/60 Hz	UC ~ 24V	
230V	24V	
48-60V		
-15/+10%, 1,2 W nom		
1) 10A, 250V~		1) Values for resistive loads
μl Tungsten /AgCdO		
2200VA, ≤ 200W (DC)		
3x10 ⁷ mechanical life		

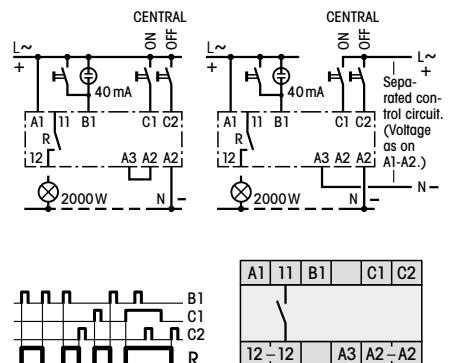

Example of order: 1 Power step-on step-off relay AL5/AC 230V

